



CE-0135-R



Camilla eléctrica tipo sillón de 3 secciones con subida recta sin desplazamiento lateral, portarrollos, tapón facial y ruedas escamoteables.

Electric couch of 3 sections with vertical elevation and no horizontal movements, a paper roll holder, a breathing hole plug and retractable wheels.

Table électrique en 3 plans avec montée à la verticale sans déplacement latéral, porte-rouleaux, bouchon facial et roulettes escamotables.

Características generales	
Tipo de cabezal	Cabezal con agujero y tapón facial
Tipo de respaldo	Elevable/reclinable
Piernas	Piecera elevable/reclinable
Otros extras incluidos	Agujero facial
	Mando de mano 1
	Portarrollos camilla
	Tapón facial
Normativas y seguridad	El motor/motores cumplen con las normativas de seguridad europeas
	PRODUCTO CE Fabricado en España

General features	
Type of headrest	Headrest with breathing hole and breathing hole plug
Type of backrest	Adjustable
Leg section	Adjustable footrest
Other extra options included	Breathing hole
	Hand switch control 1
	Paper roll holder
	Breathing hole plug
Rules and security	The engines meet the European safety regulation CE marking product. Made in Spain

Caracteristiques generales	
Type de tête	Tête avec trou et bouchon facial
Type de dossier	Réglable
Jambes	Repose-pieds réglable
Extras supplémentaires compris	Trou visage
	Commande manuelle 1
	Porte-rouleaux
Normes et sécurité	Les moteurs se conforment aux normes de sécurité européennes
	Produit CE. Fabriqué en Espagne

Estructura y chasis	
Tipo de estructura	Tijera, con subida recta sin desplazamiento
Peso soportado	180 kg
Material	Tubo de acero recubierto de polvo epoxy, cocido en horno a 210°C
Pintura	Blanco

Frame and chassis	
Type of frame	Scissor with vertical elevation and no movements
Lifting capacity	180 kg
Material	Steel tube coated with an epoxy powder coating and oven-baked at 210°C
Paint	White

Structure et châssis	
Type de structure	Ciseaux avec montée à la verticale sans déplacement
Poids supporté	180 kg
Matériel	Châssis mécano soudé en acier. Finition: peinture poudre époxy cuite au four à 210°C
Peinture	Blanc

Funcionalidades	
Tipo de motor	Eléctrico
Número de motores	1
Funcionalidades motorizadas	Altura
Funcionalidades mediante pistón de gas	Piecera
	Respaldo
Tipo de altura	Regulable
Otros	Subida recta sin desplazamiento lateral

Functionalities	
Type of motor	Electric
Quantity of motors	1
Motorised functionalities	Height
Functionalities by a gas strut	Footrest
	Backrest
Type of height	Adjustable
Others	Vertical elevation without horizontal movements

Fonctionnalités	
Type de moteur	Électrique
Nombre de moteurs	1
Fonctionnalités motorisées	Hauteur
Fonctionnalités par un vérin à gaz	Repose-pieds
	Dossier
Type de hauteur	Réglable
Autres	Montée à la verticale sans déplacement latéral

Ruedas	
Sistema de ruedas	Escamoteables mediante pedal único
Tipo de ruedas	Ruedas dobles de Ø 50mm

Wheels	
Wheel system	Retractable by a single pedal
Type of wheels	Double wheels of Ø 50 mm

Roulettes	
Système de roulettes	Escamotables par une seule pédale
Type de roulettes	Roulettes doubles de Ø 50 mm

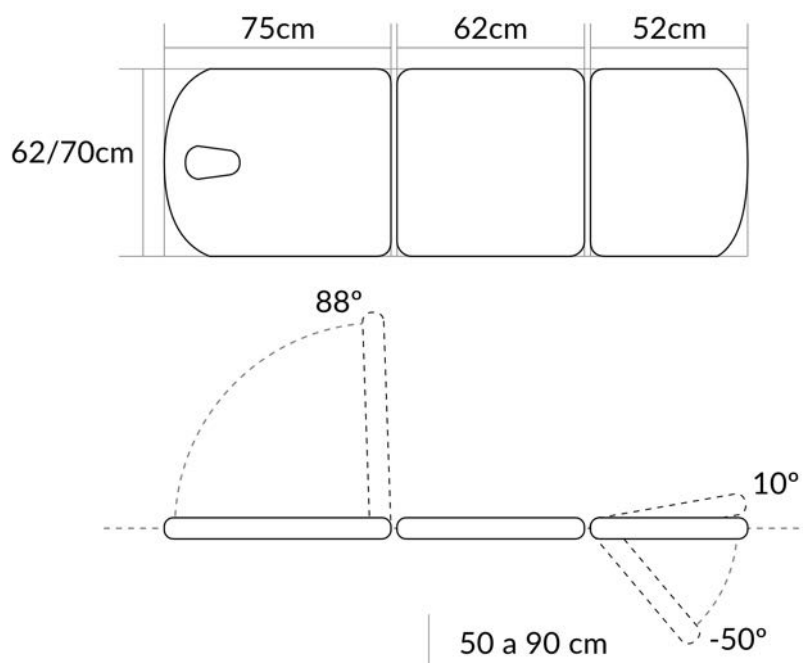

Espuma

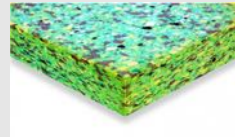
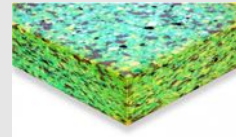
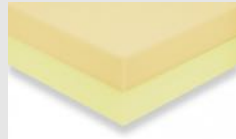
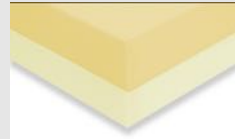
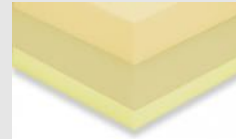
E30/5
5cm 30Kg/m³E60/3
3cm 60Kg/m³E60/5
5cm 60Kg/m³E150/3
3cm 150Kg/m³E150/5
5cm 150Kg/m³E30/3+2V
3cm 30Kg/m³ + 2cm viscoE30/5+2V
5cm 30Kg/m³ + 2cm viscoE30/4+4V
4cm 30Kg/m³ + 4cm viscoE30/5+4V
5cm 30Kg/m³ + 4cm viscoE60/3+30/2
3cm 60Kg/m³ + 2cm 30Kg/m³E60/2+30/5+4V
2cm 60Kg/m³ + 5cm 30Kg/m³ + 4cm visco

Color estructura

ECB
BlancaECG
Gris plateadoECA
AntracitaECN
Negra

Mando

MM1
Mando de mano 1 motorMP1
Mando de pie 1 motorPERBO
Periférico blanco omegaPERBL
Periférico blanco lateral

Reposabrazos

BAT
Brazos apoyo al terapeuta (2 unidades)REX
Reposabrazos extracción (tapizado acanalado)REXROT
Reposabrazos extracción con rótula (tapizado acanalado)RP
Reposabrazos plano tapizadoRAA
Reposabrazos regulable en altura y apertura (tapizado)

Reposapiés

ESTR
EstríberasPG
Juego perneras ginecológicasPGR
Juego perneras ginecológicas con rótula

Ruedas

SRE
Sistema de ruedas escamoteables

Accesorios



PTB
Portarrollos base



SB
Soportes genéricos (2 u.)



GUILAT2
Guias laterales 110cm



RE
Rulo enyesado



AF
Agujero facial



TF-01
Tapón facial



RSA
Respaldo sin agujero facial



CER
Cojín ergonómico respaldo
(sillones)







CAM
Cabezal acoplado madera





Foam

					
E30/5 5cm 30Kg/m ³	E60/3 3cm 60Kg/m ³	E60/5 5cm 60Kg/m ³	E150/3 3cm 150Kg/m ³	E150/5 5cm 150Kg/m ³	E30/3+2V 3cm 30Kg/m ³ + 2cm visco
					
E30/5+2V 5cm 30Kg/m ³ + 2cm visco	E30/4+4V 4cm 30Kg/m ³ + 4cm visco	E30/5+4V 5cm 30Kg/m ³ + 4cm visco	E60/3+30/2 3cm 60Kg/m ³ + 2cm 30Kg/m ³	E60/2+30/5+4V 2cm 60Kg/m ³ + 5cm 30Kg/m ³ + 4cm visco	





Structure colour

			
ECB White	ECG Silvered grey	ECA Antracita	ECN Black

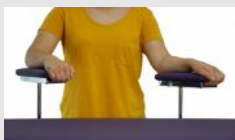

Switch control

			
MM1 1 motor hand switch control	MP1 1 motor foot switch	PERBO Omega white perimeter foot switch	PERBL Lateral white perimeter foot switch

Armrests

				
BAT Armrests for supporting the therapist (2 units)	REX Phlebotomy armrests (fluted upholstery)	REXROT Phlebotomy swivel armrests (fluted upholstery)	RP Flat upholstered armrest	RAA Adjustable height and angle armrest

Footrest

		
ESTR Stirrups	PG Set of gynaecological leg supports	PGR Set of swivel gynaecological leg supports

Wheels

SRE Retractable wheels system

Accessories



PTB
Paper roll holder at the base



SB
Generic supports (2 u.)



GUILAT2
Lateral guides 110cm



RE
Plastering roll



AF
Breathing hole



TF-01
Breathing hole plug



RSA
Headrest without facial hole plug



CER
Ergonomic cushion for the
backrest



CAM
Coupled wooden headrest

Mousse

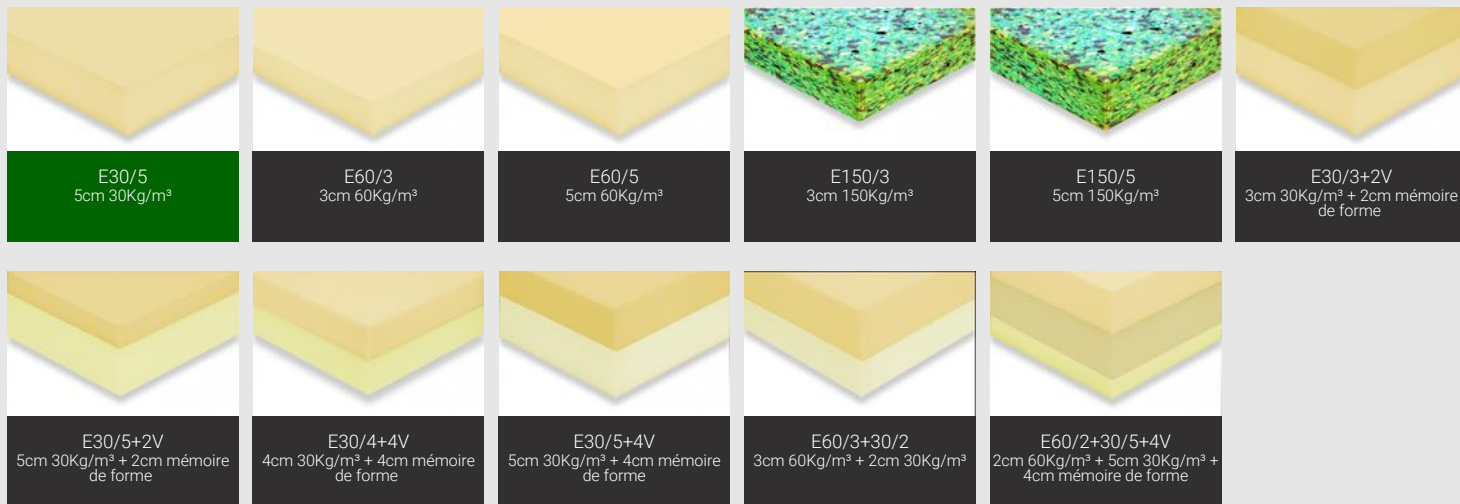

Couleur de la structure



Commande

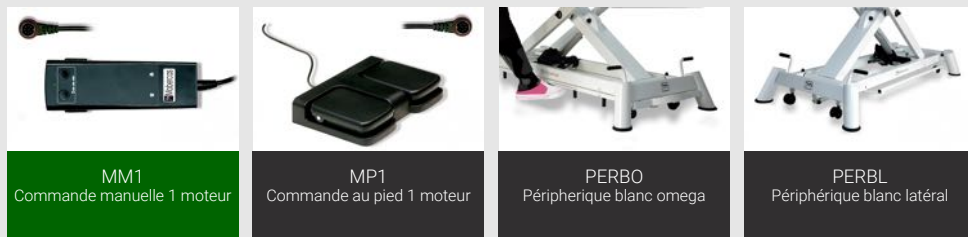

Accoudoirs



Repose-pieds



Roulettes



Accessoires



PTB
Porte-rouleaux à la base



SB
Étaux (2 u.)



GUILAT2
Guides latéraux 110cm



RE
Rouleau plâtré



AF
Trou visage



TF-01
Bouchon facial



RSA
Dossier sans trou visage



CER
Coussin ergonomique pour le dossier (fauteuils)



CAM
Tête en bois adaptable