

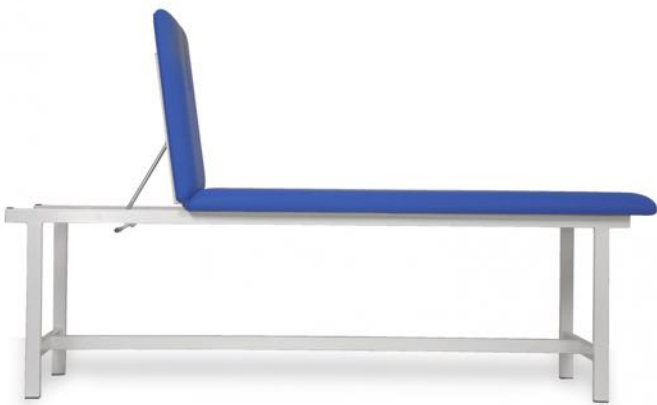

CF-BASKET-20



Camilla fija extralarga de 2 secciones ideal para equipos de baloncesto. Incluye portarrollos y tapón facial.

King-sized fixed couch of 2 sections ideal for basketball teams. It includes a paper roll holder and a breathing hole plug.

Table extralonge à hauteur fixe en 2 plans idéale pour les équipes de basket. Porte-rouleaux et bouchon facial compris.

Características generales	
Tipo de cabezal	Cabezal con agujero y tapón facial
Tipo de respaldo	Elevable/reclinable
Otros extras incluidos	Agujero facial
	Portarrollos camilla
	Tapón facial
Normativas y seguridad	PRODUCTO CE Fabricado en España

Estructura y chasis	
Peso soportado	300 kg
Material	Tubo de acero recubierto de polvo epoxi, cocido en horno a 210°C
Pintura	Blanco

Funcionalidades	
Tipo de motor	Sin motor
Funcionalidades mediante palanca	Respaldo
Tipo de altura	Fija

General features	
Type of headrest	Headrest with breathing hole and breathing hole plug
Type of backrest	Adjustable
Other extra options included	Breathing hole
	Paper roll holder
	Breathing hole plug
Rules and security	CE marking product. Made in Spain

Frame and chassis	
Lifting capacity	300 kg
Material	Steel tube coated with an epoxy powder coating and oven-baked at 210°C
Paint	White

Functionalities	
Type of motor	Without motor
Functionalities by lever system	Backrest
Type of height	Fixed

Caracteristiques generales	
Type de tête	Tête avec trou et bouchon facial
Type de dossier	Réglable
Extras supplémentaires compris	Trou visage
	Porte-rouleaux
	Bouchon facial
Normes et sécurité	Produit CE. Fabriqué en Espagne

Structure et châssis	
Poids supporté	300 kg
Matériel	Châssis mécano soudé en acier. Finition: peinture poudre époxy cuite au four à 210°C
Peinture	Blanc

Fonctionnalités	
Type de moteur	Sans moteur
Fonctionnalités par système de leviers	Dossier
Type de hauteur	Fixe

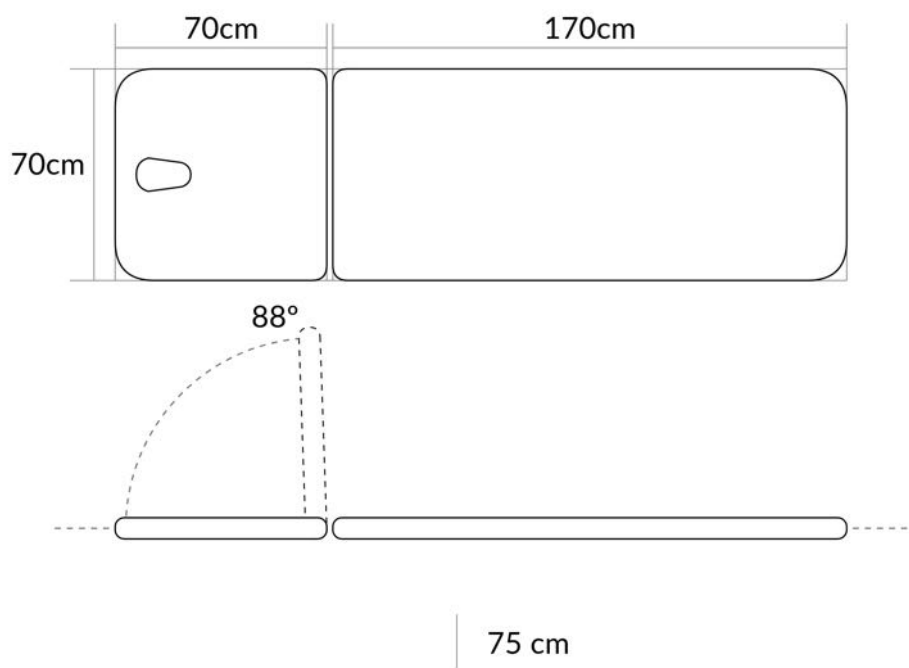

Espuma

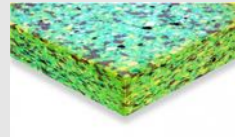
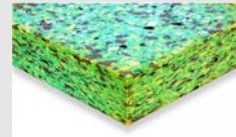
E30/5
5cm 30Kg/m³E60/3
3cm 60Kg/m³E60/5
5cm 60Kg/m³E150/3
3cm 150Kg/m³E150/5
5cm 150Kg/m³E30/3+2V
3cm 30Kg/m³ + 2cm viscoE30/5+2V
5cm 30Kg/m³ + 2cm viscoE30/4+4V
4cm 30Kg/m³ + 4cm viscoE30/5+4V
5cm 30Kg/m³ + 4cm viscoE60/3+30/2
3cm 60Kg/m³ + 2cm 30Kg/m³E60/2+30/5+4V
2cm 60Kg/m³ + 5cm 30Kg/m³ + 4cm visco

Color estructura

ECB
BlancaECG
Gris plateadoECA
AntracitaECN
Negra

Reposabrazos

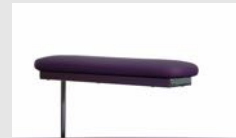
BAT
Brazos apoyo al terapeuta (2 unidades)REX
Reposabrazos extracción (tapizado acanalado)REXROT
Reposabrazos extracción con rótula (tapizado acanalado)RP
Reposabrazos plano tapizadoRAA
Reposabrazos regulable en altura y apertura (tapizado)

Reposapiés

ESTR
EstriberasPG
Juego perneras ginecológicasPGR
Juego perneras ginecológicas con rótula



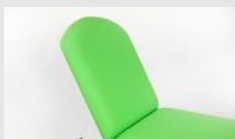

Accesorios

PT
PortarrollosSB
Soportes genéricos (2 u.)GUILAT1
Guías laterales 126cmRE
Rulo enyesadoAF
Agujero facialTF-01
Tapón facialRSA
Respaldo sin agujero facialCER
Cojín ergonómico respaldo (sillones)

Foam

					
E30/5 5cm 30Kg/m ³	E60/3 3cm 60Kg/m ³	E60/5 5cm 60Kg/m ³	E150/3 3cm 150Kg/m ³	E150/5 5cm 150Kg/m ³	E30/3+2V 3cm 30Kg/m ³ + 2cm visco
					
E30/5+2V 5cm 30Kg/m ³ + 2cm visco	E30/4+4V 4cm 30Kg/m ³ + 4cm visco	E30/5+4V 5cm 30Kg/m ³ + 4cm visco	E60/3+30/2 3cm 60Kg/m ³ + 2cm 30Kg/m ³	E60/2+30/5+4V 2cm 60Kg/m ³ + 5cm 30Kg/m ³ + 4cm visco	



Structure colour

				
ECB White	ECG Silvered grey	ECA Antracita	ECN Black	









Armrests

				
BAT Armrests for supporting the therapist (2 units)	REX Phlebotomy armrests (fluted upholstery)	REXROT Phlebotomy swivel armrests (fluted upholstery)	RP Flat upholstered armrest	RAA Adjustable height and angle armrest

Footrest

		
ESTR Stirrups	PG Set of gynaecological leg supports	PGR Set of swivel gynaecological leg supports

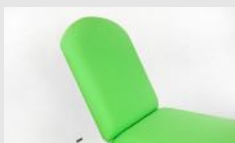
Accessories

					
PT Paper roll holder	SB Generic supports (2 u.)	GUILAT1 Lateral guides 126cm	RE Plastering roll	AF Breathing hole	TF-01 Breathing hole plug
					
RSA Headrest without facial hole plug	CER Ergonomic cushion for the backrest				

Mousse

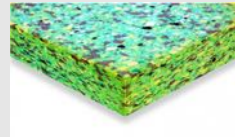
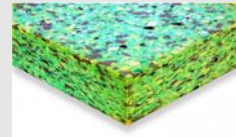
E30/5
5cm 30Kg/m³E60/3
3cm 60Kg/m³E60/5
5cm 60Kg/m³E150/3
3cm 150Kg/m³E150/5
5cm 150Kg/m³E30/3+2V
3cm 30Kg/m³ + 2cm mémoire
de formeE30/5+2V
5cm 30Kg/m³ + 2cm mémoire
de formeE30/4+4V
4cm 30Kg/m³ + 4cm mémoire
de formeE30/5+4V
5cm 30Kg/m³ + 4cm mémoire
de formeE60/3+30/2
3cm 60Kg/m³ + 2cm 30Kg/m³E60/2+30/5+4V
2cm 60Kg/m³ + 5cm 30Kg/m³ +
4cm mémoire de forme

Couleur de la structure

ECB
BlancheECG
GriseECA
AnthraciteECN
Noir

Accoudoirs

BAT
Bras de soutien pour le
thérapeute (2 unités)REX
Accoudoirs pour l'extraction de
sang (tapissérie ondulé)REXROT
Accoudoirs articulés pour
l'extraction de sang (tapissérie
ondulé)RP
Accoudoirs plats tapissésRAA
Accoudoir réglable en hauteur et
en ouverture

Repose-pieds

ESTR
ÉtriersPG
Jeu de repose-jambes
gynécologiquesPGR
Jeu de repose-jambes
gynécologiques et articulés

Accessoires

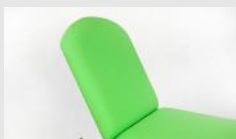
PT
Porte-rouleauxSB
Étaux (2 u.)GUILAT1
Guides latéraux 126cmRE
Rouleau plâtréAF
Trou visageTF-01
Bouchon facialRSA
Dossier sans trou visageCER
Coussin ergonomique pour le
dossier (fauteuils)